







Available Tip Styles

Material	Tip Style	ϕ mm
B	F 	3,00
		4,00
		6,00
B	D 	4,00
B	BJ 	4,00
B	HS 	1,50
		3,00
B	HB 	4,00
		6,00
		8,00
B	V 	3,00
		4,00

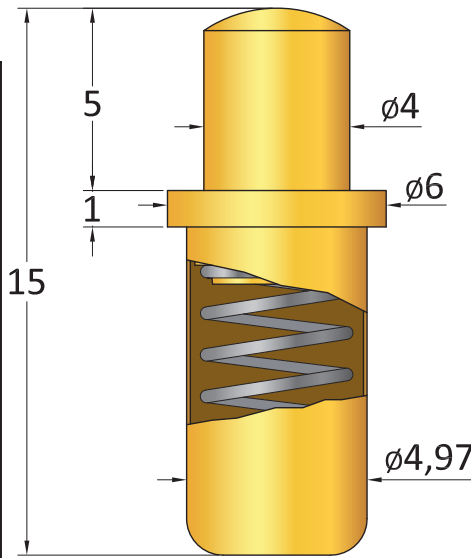

Technical Data

Recommended minimum centers:	6,50 mm
Recommended working stroke:	3,20 mm
Maximum stroke:	4,00 mm
Current rating:	8,0 A
Typical contact resistance:	<30 m Ω
Operating temperature range:	-50° up to +100°

Materials

Plunger:	Brass or BeCu, nickel or gold plated
Barrel:	Brass, gold plated
Spring:	Stainless steel
Receptacle:	Brass, gold plated

Spring Force (g $\pm 20\%$)

Spring force:	150 g
Alternative:	300 g
	400 g
	800 g

Hole size without receptacle

Drills: $\phi 4,96 - \phi 4,97$

Hole size with receptacle

Drills: $\phi 5,59 - \phi 5,60$

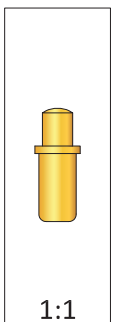
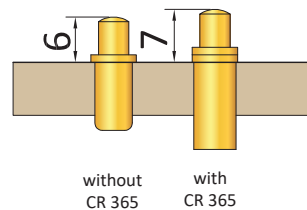
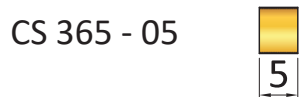
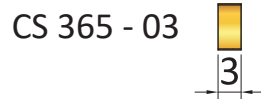
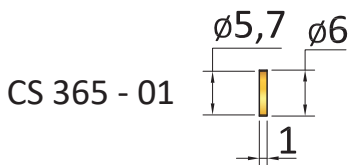
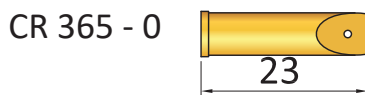
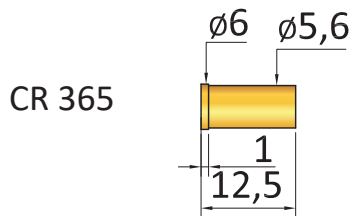

Ordering example:

Series	Tip ϕ mm	Spring Force			
CP 365	D	400	Br	150	G
	Tip Style		Material		Plating
			B=BeCu		G=Gold
			Br=Brass		N=Nickel