

## SERIE CP300

### Pointe de test pneumatique 160 mil / 4.0 mm

- Contacting of individual test points
- Contacting without adapter possible
- For use in function test

#### Mechanical Data

Center	4.00 mm / 160 mil
Full Travel	10.00 mm
Working Travel	6.00 mm
Spring Force at Working Travel	1.50 N
Operating Pressure	6 bar
Operating Medium	Compressed Air (filtered, oil-free)

#### Electrical Data

Max. Current Rating	3.0 A
Typical Continuity Resistance	≤ 30 mOhm

#### Materials

Barrel	Brass, gold plated
Spring	Spring Steel, gold plated
Plunger	Steel
Receptacle	Brass, gold plated

#### Recommended Diameter of Drill

HP 2361.1 (Trolitax)	3.40 mm
HGW 2372 (Glass filled Material)	3.41 mm

#### Tip Style - Diameter - Plating

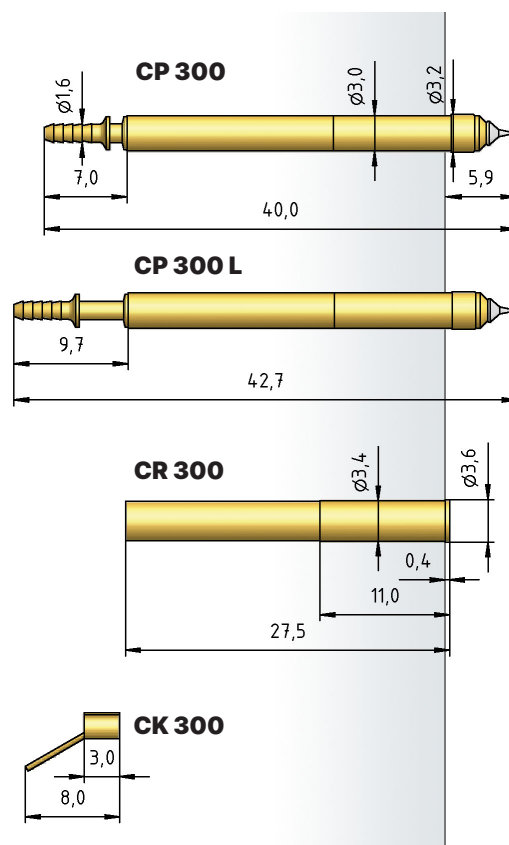

Series	Tip $\varnothing$ mm	Spring Force			
CP 300	BAS	200	S	150	R
	Tip Style		Material		Tip Plating