

F075

Up to 4 A | 75 mil | ICT application



Electrical specifications

Current [A]	4
R <sub>TYP</sub> [mOhm]	<20

Mechanical specifications

Temperature [°C]	-45°...+100°		
Preload [cN]	50	70	100
Spring force [cN] at nt ±20%	100	150	280
Nominal travel [mm]	4.3	4.3	4.3
Maximum travel [mm]	6.4	6.4	6.4

Materials and plating

Plunger	BeCu	gold plated
Barrel	Nickel silver	gold plated
Spring	Spring steel	silver plated
Receptacle	Nickel silver	gold plated

Accessories

1010808	H075LA-7.6	Receptacle
1008325	FEWZ-075EV	Insertion tool receptacle
1003587	FDWZ-075	Insertion tool probe

\* Overview of other receptacles H075 on page 52+53

Drill size recommendation (mm)

H075...	Press ring as stop	1.29 - 1.30
H075...	Press ring inserted	1.36 - 1.40

Series drawing

All measurements are in mm.

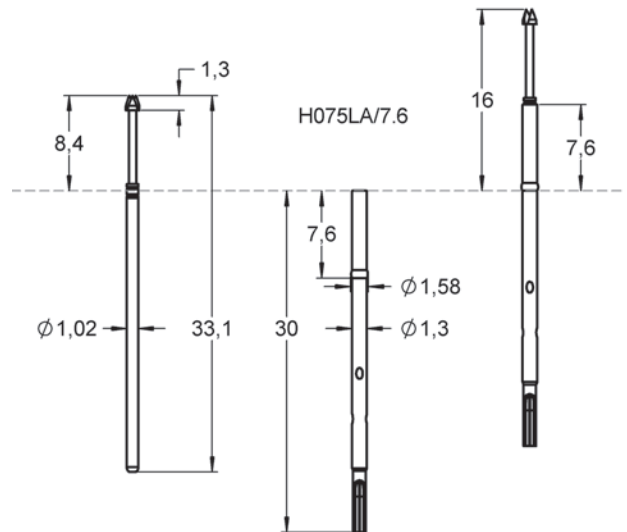









































Order code	Product name	Tip Style	Tip Ø [mm]	Material/Plating	Force [cN]	Thread [M]	Version	FM Choice
1017309	F07505B120G150	05	1.20	B / G	150	-	-	
1017478	F07505B120G200	05	1.20	B / G	200	-	-	
1010962	F07505B120G280	05	1.20	B / G	280	-	-	
1018425	F07506B100G200	06	1.00	B / G	200	-	-	-

# BASIC PROBES 75 MIL

Order code	Product name	Tip Style	Tip Ø [mm]	Material/Plating	Force [cN]	Thread [M]	Version	FM Choice
1014318	F07506B120G100	06 	1.20	B / G	100	-	-	
1017310	F07506B120G150	06 	1.20	B / G	150	-	-	
1017504	F07506B120G200	06 	1.20	B / G	200	-	-	
1001394	F07506B120G280	06 	1.20	B / G	280	-	-	
1017337	F07506B130G150IK04	06 	1.30	B / G	150	-	IK04	
1017486	F07506B130G200IK04	06 	1.30	B / G	200	-	IK04	
1017351	F07506B130G280IK04	06 	1.30	B / G	280	-	IK04	
1018424	F07507S120L200	07 	1.20	S / L	200	-	-	
1112258	F07507S120L200H	07 	1.20	S / L	200	-	H	
1017451	F07510S050L100RP	10 	0.50	S / L	100	-	RP	-
1017311	F07510S050L150RP	10 	0.50	S / L	150	-	RP	-
1017250	F07510S064L100	10 	0.64	S / L	100	-	-	-
1017312	F07510S064L150	10 	0.64	S / L	150	-	-	-
1007813	F07510S064L280	10 	0.64	S / L	280	-	-	-
1017251	F07511B064G100	11 	0.64	B / G	100	-	-	
1017313	F07511B064G150	11 	0.64	B / G	150	-	-	-
1017515	F07511B064G200	11 	0.64	B / G	200	-	-	-
1007430	F07511B064G280	11 	0.64	B / G	280	-	-	
1004062	F07514S078L280	14 	0.78	S / L	280	-	-	-
1109249	F07514S120L100	14 	1.20	S / L	100	-	-	
1017288	F07514S120L150	14 	1.20	S / L	150	-	-	
1017552	F07514S120L200	14 	1.20	S / L	200	-	-	
1007434	F07514S120L280	14 	1.20	S / L	280	-	-	
1000750	F07515B090G200	15 	0.90	B / G	200	-	-	
1017265	F07515B120G100	15 	1.20	B / G	100	-	-	
1017299	F07515B120G150	15 	1.20	B / G	150	-	-	
1017516	F07515B120G200	15 	1.20	B / G	200	-	-	
1001395	F07515B120G280	15 	1.20	B / G	280	-	-	
1017314	F07517B120G100	17 	1.20	B / G	100	-	-	-
1017300	F07517B120G150	17 	1.20	B / G	150	-	-	-
1017506	F07517B120G200	17 	1.20	B / G	200	-	-	-
1014557	F07518B064G180H	18 	0.64	B / G	180	-	H	-

# BASIC PROBES 75 MIL

Order code	Product name	Tip Style	Tip Ø [mm]	Material/Plating	Force [cN]	Thread [M]	Version	FM Choice
1001396	F07518B078G280	18 	0.78	B / G	280	-	-	-
1017297	F07521S064L100	21 	0.64	S / L	100	-	-	
1017319	F07521S064L150	21 	0.64	S / L	150	-	-	
1017502	F07521S064L200	21 	0.64	S / L	200	-	-	
1005299	F07521S064L280	21 	0.64	S / L	280	-	-	
1017320	F07530S064L150	30 	0.64	S / L	150	-	-	-
1139344	F07530S064L200	30 	0.64	S / L	200	-	-	-
1007803	F07530S064L280	30 	0.64	S / L	280	-	-	-
1017266	F07533S064L100	33 	0.64	S / L	100	-	-	
1017283	F07533S064L150	33 	0.64	S / L	150	-	-	
1017518	F07533S064L200	33 	0.64	S / L	200	-	-	
1006812	F07533S064L280	33 	0.64	S / L	280	-	-	
1001397	F07533S078L280	33 	0.78	S / L	280	-	-	-
1092210	F07535S050L280	35 	0.50	S / L	280	-	-	
1017551	F07536B120G200	36 	1.20	B / G	200	-	-	
1001398	F07536B120G280	36 	1.20	B / G	280	-	-	
1006727	F07537B050G150	37 	0.50	B / G	150	-	-	-
1017505	F07537B050G200	37 	0.50	B / G	200	-	-	-
1004759	F07537B050G280	37 	0.50	B / G	280	-	-	-
1017415	F07538S064L150	38 	0.64	S / L	150	-	-	-
1017477	F07538S064L200	38 	0.64	S / L	200	-	-	-
1007799	F07538S064L280	38 	0.64	S / L	280	-	-	-
1017352	F07541B130G280IK04	41 	1.30	B / G	280	-	-	-
1017280	F07543S064L100	43 	0.64	S / L	100	-	-	
1017416	F07543S064L150	43 	0.64	S / L	150	-	-	
1017519	F07543S064L200	43 	0.64	S / L	200	-	-	
1007594	F07543S064L280	43 	0.64	S / L	280	-	-	
1035081	F07553S064L280	53 	0.64	S / L	280	-	-	
1007607	F07563S120L130	63 	1.20	S / L	130	-	-	
1017417	F07563S120L150	63 	1.20	S / L	150	-	-	
1017490	F07563S120L200	63 	1.20	S / L	200	-	-	
1008310	F07563S120L280	63 	1.20	S / L	280	-	-	