

F100

Up to 5 A | 100 mil | ICT application



Electrical specifications

Current [A]	5
R _{TYP} [mOhm]	<20

Mechanical specifications

Temperature [°C]	-45°...+100°		
Preload [cN]	80	80	150
Spring force [cN] at nt ±20%	150	200	300
Nominal travel [mm]	4.3	4.3	4.3
Maximum travel [mm]	6.4	6.4	6.4

Materials and plating

Plunger	BeCu	gold plated
Barrel	Nickel silver	gold plated
Spring	Spring steel	silver plated
Receptacle	Nickel silver	gold plated

Accessories

1010818	H100LA-7.6	Receptacle
1008392	FEWZ-100EV	Insertion tool receptacle
1003566	FDWZ-100	Insertion tool probe

* Overview of other receptacles H100 on page 34+35

Drill size recommendation (mm)

H100...	Press ring as stop	1.67 - 1.69
H100...	Press ring inserted	1.70 - 1.75





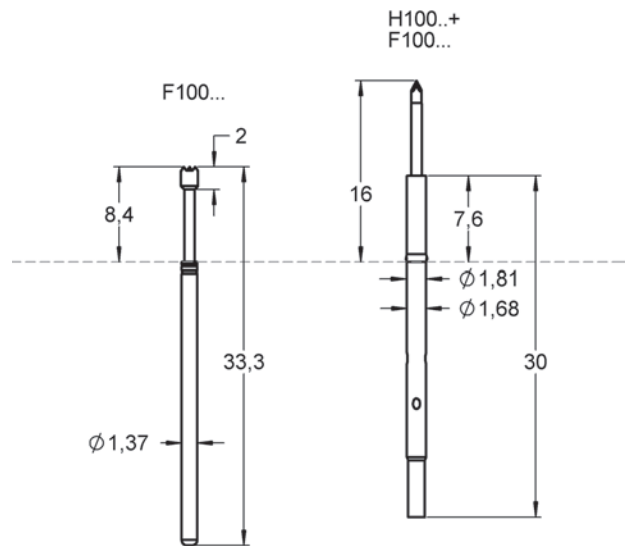



















































Series drawing

All measurements are in mm.















Order code	Product name	Tip Style	Tip Ø [mm]	Material/Plating	Force [cN]	Thread [M]	Version	FM Choice
1043597	F10002B170G200	02	1.50	B / G	180	-	-	FM Choice
1017531	F10005B150G150	05	1.50	B / G	180	-	-	FM Choice
1011718	F10005B150G200	05	1.50	B / G	300	-	-	FM Choice
1038949	F10005B150G200H	05	0.90	B / G	180	-	-	FM Choice

BASIC PROBES 100 MIL

Order code	Product name	Tip Style	Tip Ø [mm]	Material/Plating	Force [cN]	Thread [M]	Version	FM Choice
1011717	F10005B150G300	05 	1.50	B / G	180	-	-	
1100496	F10005B200G200	05 	2.00	B / G	200	-	-	-
1017563	F10006B130G150	06 	1.30	B / G	150	-	-	
1012285	F10006B130G200	06 	1.30	B / G	200	-	-	
1043598	F10006B130G200H	06 	1.30	B / G	200	-	H	
1012286	F10006B130G300	06 	1.30	S / L	300	-	-	
1006750	F10006B150G150	06 	1.50	S / L	150	-	-	-
1013049	F10006B150G200	06 	1.50	S / L	200	-	-	
1013692	F10006B150G200H	06 	1.50	S / P	200	-	H	
1013033	F10006B150G200IK04	06 	1.50	B / G	200	-	IK04	
1010698	F10006B150G300	06 	1.50	B / G	300	-	-	
1013034	F10006B150G300IK04	06 	1.50	S / L	300	-	IK04	
1012591	F10006B200G150	06 	2.00	S / L	150	-	-	
1012592	F10006B200G200	06 	2.00	S / L	200	-	-	
1011380	F10006B200G200IK04	06 	2.00	S / P	200	-	IK04	
1012593	F10006B200G300	06 	2.00	S / P	300	-	-	
1011381	F10006B200G300IK04	06 	2.00	S / L	300	-	IK04	
1017533	F10006B250G150	06 	2.50	S / L	150	-	-	
1013012	F10006B250G200	06 	2.50	S / L	200	-	-	
1011395	F10006B250G300	06 	2.50	B / G	300	-	-	
1040167	F10006B250G400	06 	2.50	B / G	400	-	-	
1017163	F10006B300G200	06 	3.00	B / G	200	-	-	-
1007901	F10006B300G300	06 	3.00	B / G	300	-	-	-
1011177	F10006B350G300IK04	06 	3.50	B / G	300	-	IK04	-
1014750	F10006B350G300IK10	06 	3.50	B / G	300	-	IK10	-
1017390	F10006B400G200	06 	4.00	B / G	200	-	-	-
1014046	F10006B400G300	06 	4.00	B / G	300	-	-	-
1011982	F10007S150L200	07 	1.50	S / L	200	-	-	
1011983	F10007S150L200H	07 	1.50	S / L	200	-	H	
1011984	F10007S150L300	07 	1.50	S / L	300	-	-	
1011853	F10007S170L200	07 	1.70	S / L	200	-	-	
1011111	F10007S170L300	07 	1.70	S / L	300	-	-	











































BASIC PROBES 100 MIL

Order code	Product name	Tip Style	Tip Ø [mm]	Material/Plating	Force [cN]	Thread [M]	Version	FM Choice
1004257	F10010S060L150	10 	0.60	S / L	150	-	-	
1017643	F10010S060L150RP	10 	0.60	S / L	150	-	RP	-
1004028	F10010S060L200	10 	0.60	S / L	200	-	-	
1004175	F10010S060L300	10 	0.60	S / L	300	-	-	
1017164	F10011B050G200	11 	0.50	B / G	200	-	-	-
1018364	F10011B064G150	11 	0.64	B / G	150	-	-	
1011581	F10011B064G200	11 	0.64	B / G	200	-	-	
1008017	F10011B064G300	11 	0.64	B / G	300	-	-	
1017534	F10011B090G150	11 	0.90	B / G	150	-	-	
1013006	F10011B090G200H	11 	0.90	S / L	200	-	H	
1011836	F10011B090G300	11 	0.90	S / L	300	-	-	
1017697	F10011B090G400	11 	0.90	S / L	400	-	-	
1092030	F10012B130G200	12 	1.30	S / P	200	-	-	-
1017710	F10012B150G150	12 	1.50	B / G	150	-	-	
1016668	F10012B150G200	12 	1.50	B / G	200	-	-	
1016669	F10012B150G300	12 	1.50	S / L	300	-	-	
1017536	F10014B130G150	14 	1.30	S / L	150	-	-	
1011719	F10014B130G200	14 	1.30	S / L	200	-	-	
1011667	F10014B130G300	14 	1.30	S / P	300	-	-	
1011007	F10014B150G200	14 	1.50	S / P	200	-	-	
1011008	F10014B150G300	14 	1.50	S / L	300	-	-	
1017696	F10014B150G400	14 	1.50	S / L	400	-	-	
1012769	F10014S130L150	14 	1.30	S / L	150	-	-	
1012782	F10014S130L200	14 	1.30	S / L	200	-	-	
1012783	F10014S130L200H	14 	1.30	S / L	200	-	H	
1012784	F10014S130L300	14 	1.30	S / L	300	-	-	
1057662	F10014S130L400	14 	1.30	S / L	400	-	-	
1017695	F10014S150L150	14 	1.50	S / L	150	-	-	
1013478	F10014S150L200	14 	1.50	S / L	200	-	-	
1013479	F10014S150L200H	14 	1.50	S / L	200	-	H	
1013480	F10014S150L300	14 	1.50	S / L	300	-	-	
1017757	F10014S150L300HP	14 	1.50	S / L	300	-	HP	

BASIC PROBES 100 MIL

Order code	Product name	Tip Style	Tip Ø [mm]	Material/Plating	Force [cN]	Thread [M]	Version	FM Choice
1017540	F10015B150G150	15 	1.50	B / G	150	-	-	-
1013342	F10015B150G200	15 	1.50	B / G	200	-	-	-
1013343	F10015B150G300	15 	1.50	B / G	300	-	-	
1011890	F10015B170G200	15 	1.70	B / G	200	-	-	
1011891	F10015B170G300	15 	1.70	B / G	300	-	-	
1014374	F10015B250G200	15 	2.50	B / G	200	-	-	
1014375	F10015B250G300	15 	2.50	B / G	300	-	-	
1043600	F10015B300G200	15 	3.00	B / G	200	-	-	-
1011261	F10016B075G200	16 	0.75	B / G	200	-	-	-
1023670	F10017B150G300	17 	1.50	B / G	300	-	-	
1015133	F10017B200G200	17 	2.00	B / G	200	-	-	
1015247	F10017B200G200H	17 	2.00	B / G	200	-	H	
1017542	F10018B090G150	18 	0.90	B / G	150	-	-	
1012175	F10018B090G200	18 	0.90	B / G	200	-	-	
1011512	F10018B090G300	18 	0.90	B / G	300	-	-	
1044769	F10021B090G200	21 	0.90	B / G	200	-	-	
1032056	F10021B090G200H	21 	0.90	B / G	200	-	H	
1017543	F10021S090L150	21 	0.90	S / L	150	-	-	
1012135	F10021S090L200	21 	0.90	S / L	200	-	-	
1007251	F10021S090L300	21 	0.90	S / L	300	-	-	-
1017544	F10030B090G150	30 	0.90	B / G	150	-	-	
1057663	F10030B090G200	30 	0.90	B / G	200	-	-	-
1007849	F10030B090G300	30 	0.90	B / G	300	-	-	
1006272	F10033S090L150	33 	0.90	S / L	150	-	-	-
1006813	F10033S090L200	33 	0.90	S / L	200	-	-	
1012860	F10033S090L200H	33 	0.90	S / L	200	-	H	
1001150	F10033S090L200HP	33 	0.90	S / L	200	-	HP	
1006541	F10033S090L300	33 	0.90	S / L	300	-	-	
1016732	F10033S150L300	33 	1.50	S / L	300	-	-	
1004187	F10035S150L200	35 	1.50	S / L	200	-	-	
1004276	F10035S150L300	35 	1.50	S / L	300	-	-	

BASIC PROBES 100 MIL

Order code	Product name	Tip Style	Tip Ø [mm]	Material/Plating	Force [cN]	Thread [M]	Version	FM Choice
1100640	F10036S130L150	36 	1.30	S / L	150	-	-	
1013145	F10036S130L200	36 	1.30	S / L	200	-	-	
1013146	F10036S130L300	36 	1.30	S / L	300	-	-	
1008651	F10037S050L200	37 	0.50	S / L	200	-	-	
1007223	F10037S050L300	37 	0.50	S / L	300	-	-	
1057664	F10038S090L150	38 	0.90	S / L	150	-	-	
1006498	F10038S090L200	38 	0.90	S / L	200	-	-	
1007709	F10038S090L300	38 	0.90	S / L	300	-	-	
1012765	F10041B150G200IK04	41 	1.50	B / G	200	-	IK04	-
1012770	F10041B150G300IK04	41 	1.50	B / G	300	-	IK04	-
1017547	F10043S090L150	43 	0.90	S / L	150	-	-	
1006908	F10043S090L200	43 	0.90	S / L	200	-	-	
1007696	F10043S090L300	43 	0.90	S / L	300	-	-	
1036161	F10043S090L300H	43 	0.90	S / L	300	-	H	
1032170	F10053S090L300	53 	0.90	S / L	300	-	-	
1017464	F10055B180G200	55 	1.80	B / G	200	-	-	-
1020072	F10055B180G200H	55 	1.80	B / G	200	-	H	
1014197	F10060B046G200	60 	0.46	B / G	200	-	-	-
1013020	F10062B090G200	62 	0.90	B / G	200	-	-	
1013022	F10062B090G300	62 	0.90	B / G	300	-	-	
1017562	F10063B150G150	63 	1.50	B / G	150	-	-	
1013103	F10063B150G200	63 	1.50	B / G	200	-	-	
1013104	F10063B150G300	63 	1.50	B / G	300	-	-	
1000078	F10068S150L200	68 	1.50	S / L	200	-	-	-
1091896	F10068S150L300	68 	1.50	S / L	300	-	-	-