

QN-Series

Accelerated life testing solution

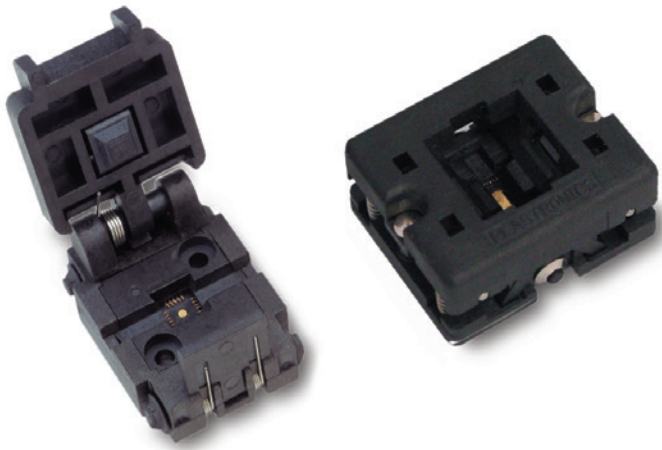

Smiths Interconnect has taken a leadership role in designing and developing socket solutions for the newest QFN packages such as MLF, BCC, and LPCC. These sockets offer a modular design in a small outline with very low inductance.

The new Open Top QFN socket allows for more convenient package loading and unloading in most of the same lead count options as the lidded version.

Burn-in sockets for high-reliability testing of next-generation IC packages

Benefits

- Industry proven design, in-house tooling, moulding and machining, with 100% automated assembly.
- Extensive catalogue of components and configurable options

Feature Options

- Available in 0.40 mm, 0.50 mm, 0.65 mm, 0.80 mm, and 1.00 mm pitches
- Custom pitches down to 0.30 mm
- Lidded and Open Top Sockets for ≤ 10 mm packages
- Lidded Sockets for 10 mm to 16 mm packages
- Centre ground pin standard for all sockets
- Optional copper heat slug available for high wattage devices
- Sockets for over 80 different JEDEC standard footprints

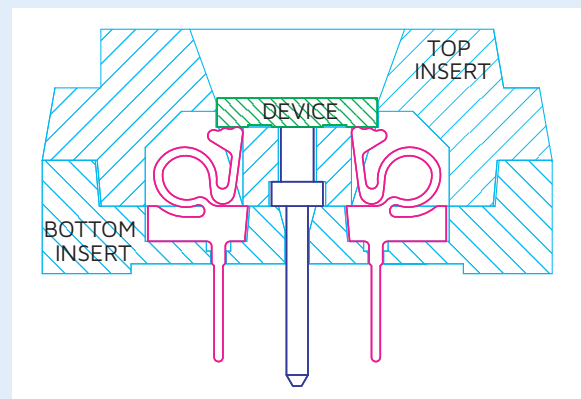

QN-Series socket specifications

Mechanical Properties:

- Mounting: Thru hole
- Socket operation: Clamshell lid; ZIF Open
- Operating temperature: -55 °C to 150 °C
- Contact Force: 32g
- Life Cycles: 5,000 mechanical cycles

Electrical Properties

- Contact resistance: <50 mΩ
- Inductance: 3 nH
- Current rating: 0.5 A with 30 °C rise, 1.0 A with 75 °C rise
- Volume resistivity: $1 \times 10^{15} \Omega\text{-cm}$
- Insulation resistance: 220.5 kV/cm

Materials

- Plastic body: PPS
- Contact base metal: BeCu
- Contact plating: Au over Ni; NiB optional
- Centre pin base metal: Brass; Cu optional
- Centre pin plating: Au
- Springs, torsion/coil: Passivated S.S.

QN-Series socket dimensions

Lidded Body Size ≤10 mm

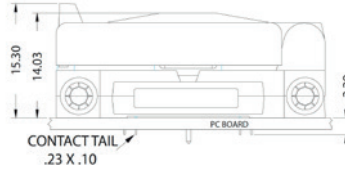
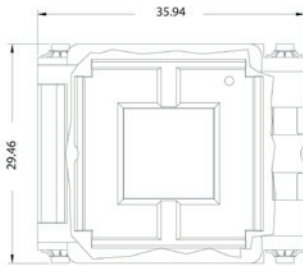

Lidded Body Size 10 mm to 16 mm

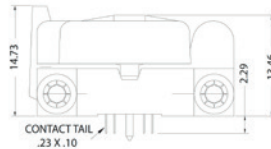
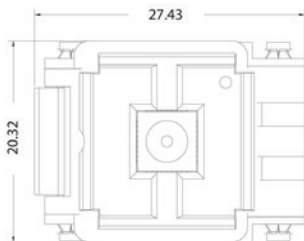

Open Top Body Size ≤10 mm

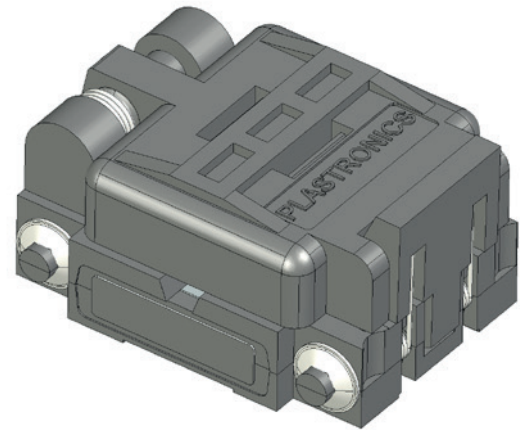
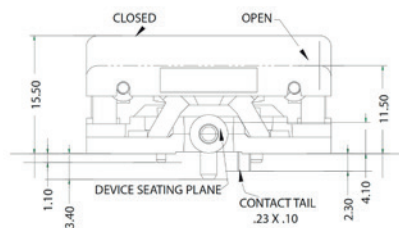
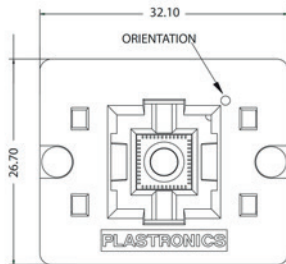

more > [smithsinterconnect.com](https://www.smithsinterconnect.com) | [in](#) [t](#) [v](#)